



SINCE 1946



# BREVETTI MONTOLIT SPA DAL 1946

BREVETTI MONTOLIT SPA è una delle più importanti Aziende al mondo che si occupa del **DESIGN, PRODUZIONE E COMMERCIALIZZAZIONE** di varie linee di **MACCHINE e UTENSILI DIAMANTATI** per la lavorazione di **PIASTRELLE, PIETRA e MATERIALI LAPIDEI**



Taglia piastrelle Manuali



Utensili Diamantati



Taglia piastrelle Elettriche



Progetto 300 per Lastre

# BREVETTI MONTOLIT SPA DAL 1946

Posizionamento del marchio: Marchio premium

Segmenti di mercato: Strumenti professionali per piastrellisti

Sede: Cantello – Varese, Italia

Siti produttivi: Italia

Portata internazionale: Copertura mondiale

Fatturato: > 35 Mln (Gruppo Montolit)

Dipendenti: 100 (Gruppo Montolit)



# BREVETTI MONTOLIT



# CRESCITA INTERNAZIONALE

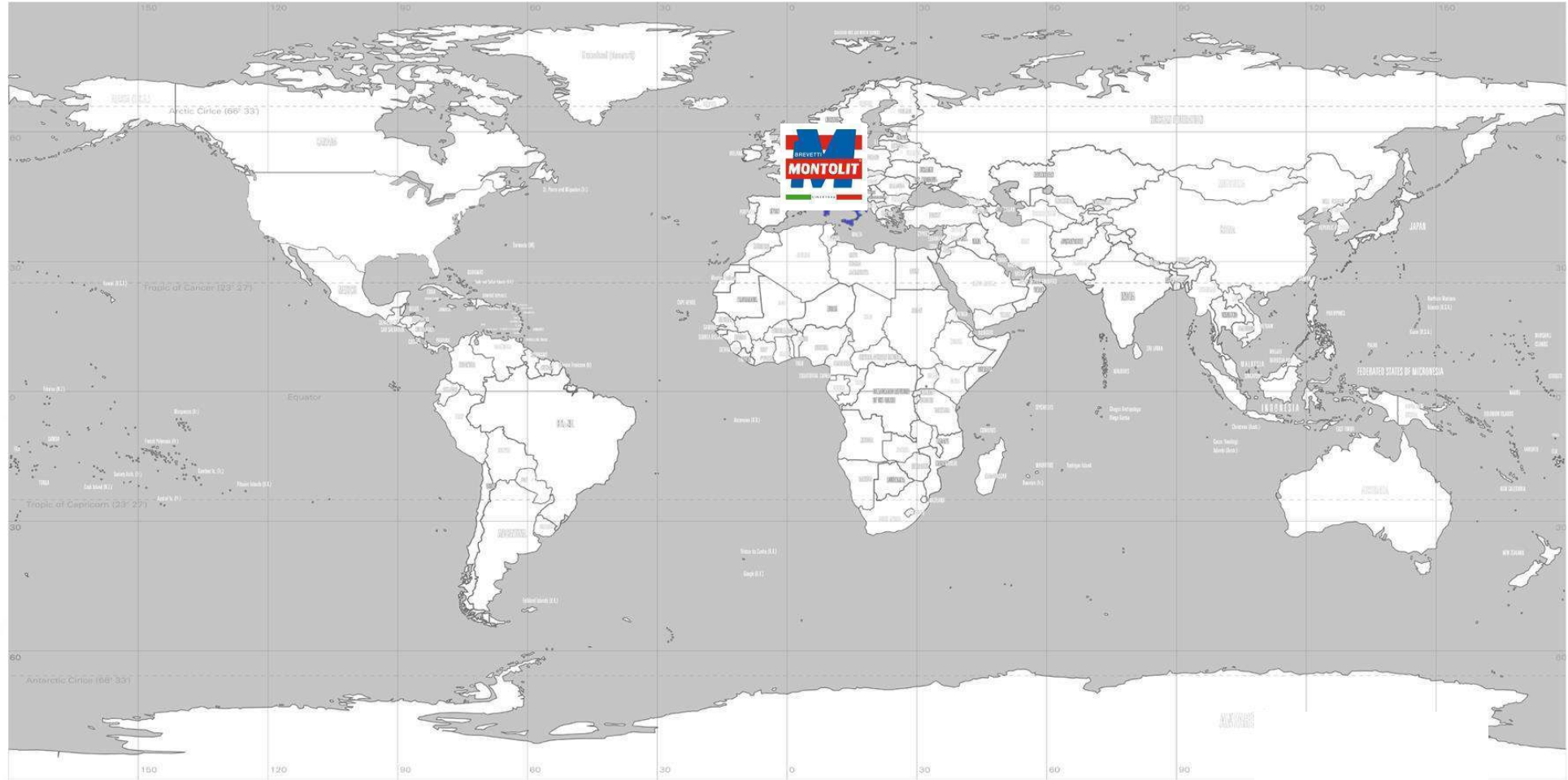

# CRESCITA INTERNAZIONALE

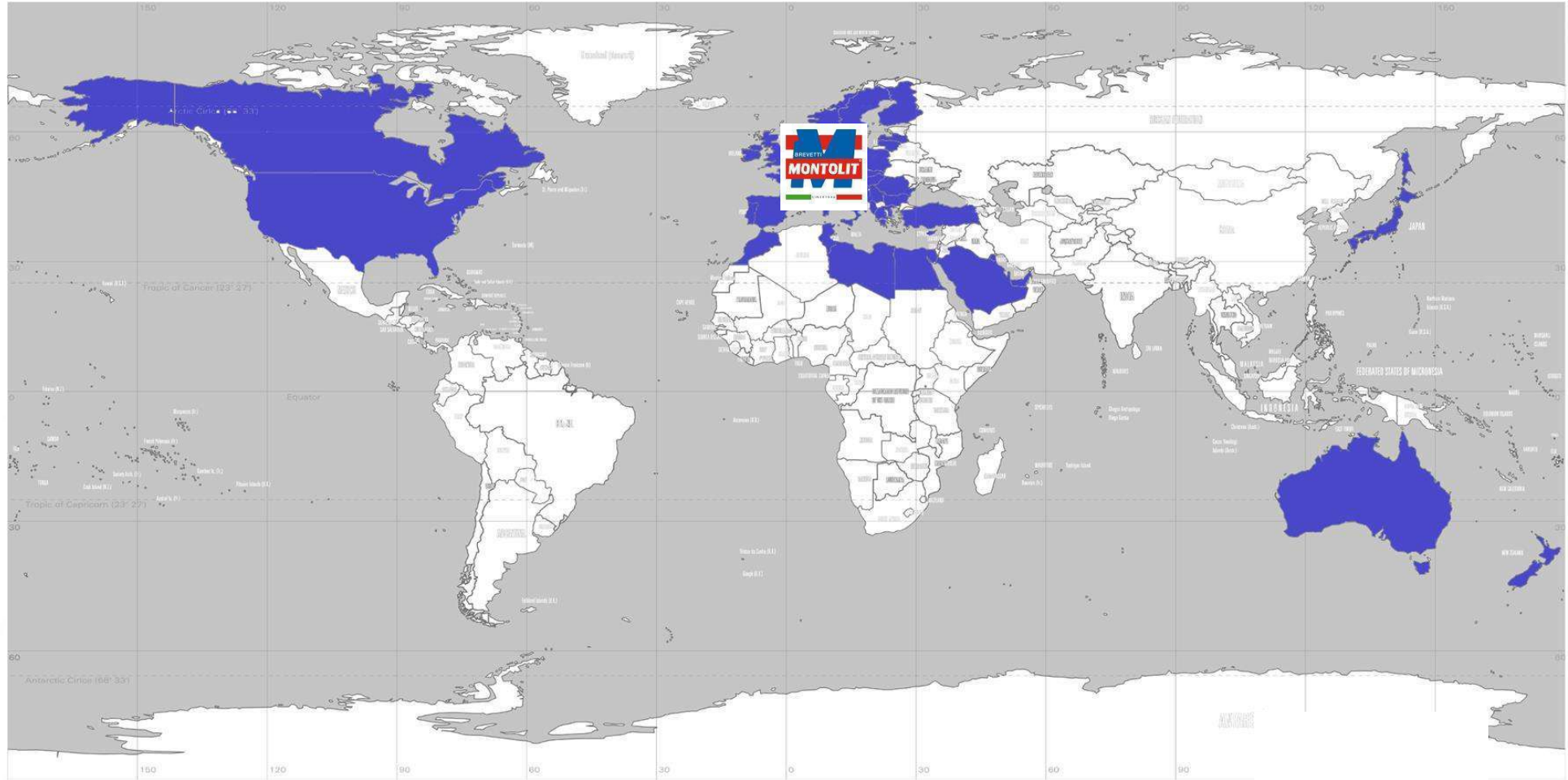



# FILOSOFIA AZIENDALE

**INNOVAZIONE**

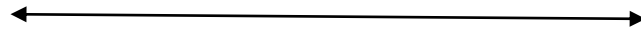

**OLTRE 500  
BREVETTI  
INTERNAZIONALI**

**QUALITA'**

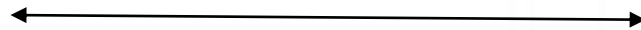

**MARCHIO  
INTERNAZIONALE  
CON PRODOTTI DI  
ALTA TECNOLOGIA**

**SODDISFAZIONE  
DELLA CLIENTELA**



**PARTERSHIP TECNICHE  
FORMAZIONE SCUOLE DI  
POSA**



# PARTNERSHIP TECNICHE CON SCUOLE PROFESSIONALI



UNIONE EUROPEA DELLE ASSOCIAZIONI NAZIONALI DI SETTORE DELLE PIASTRELLE  
THE EUROPEAN UNION OF NATIONAL TILE INSTALLER ASSOCIATIONS  
UNION EUROPÉENNE DES FEDERATIONS DES ENTREPRISES DE CARRELAGE  
DIE EUROPÄISCHE UNION NATIONALER FLIESENFACHVERBÄNDE  
LA UNION EUROPEA NACIONAL ASOCIACIONES PROFESIONALES DE AZULEJOS



SPV  
ASC  
ASP



SCHWEIZERISCHER PLATTENVERBAND  
ASSOCIATION SUISSE DU CARRELAGE  
ASSOCIAZIONE SVIZZERA DELLE PIASTRELLE  
SWITZERLAND ASSOCIATION OF TILES  
ASOCIACIÓN SUIZA DE AZULEJOS



BELGIAN INNOVATIVE TILE ACADEMY

MEINE AUSBILDUNG



# PARTNERSHIP TECNICO COMMERCIALI

**LITOKOL**<sup>®</sup>  
HI-PERFORMANCE BUILDING PRODUCTS



 **MAPEI**<sup>®</sup>  
ADHESIVES • SEALANTS • CHEMICAL PRODUCTS FOR BUILDING



**KERAKOLL**  
The GreenBuilding Company



# PRODUCTS RANGE – TAGLIA PIASTRELLE MANUALI

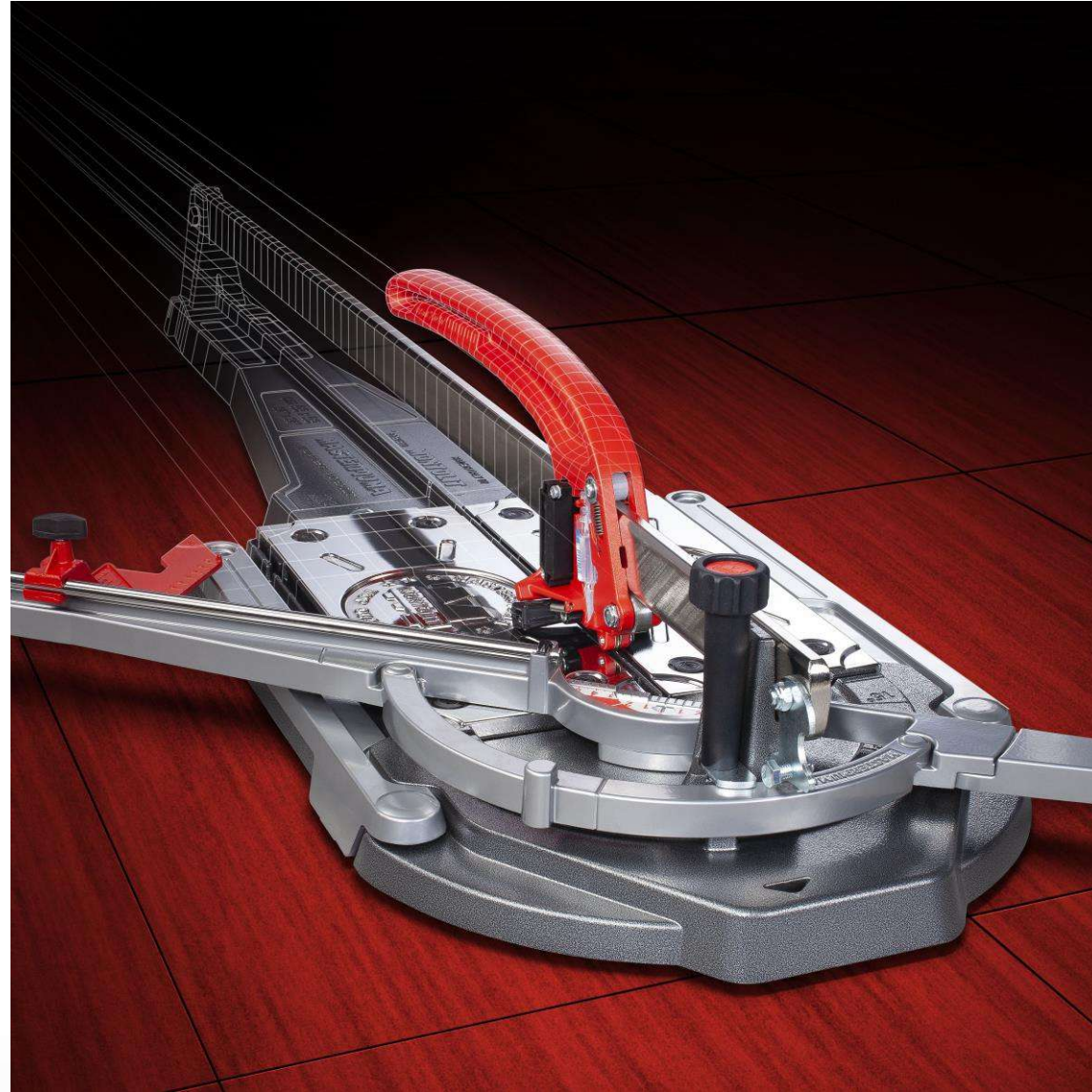

# PRODUCTS RANGE – NEW MASTERPIUMA P5

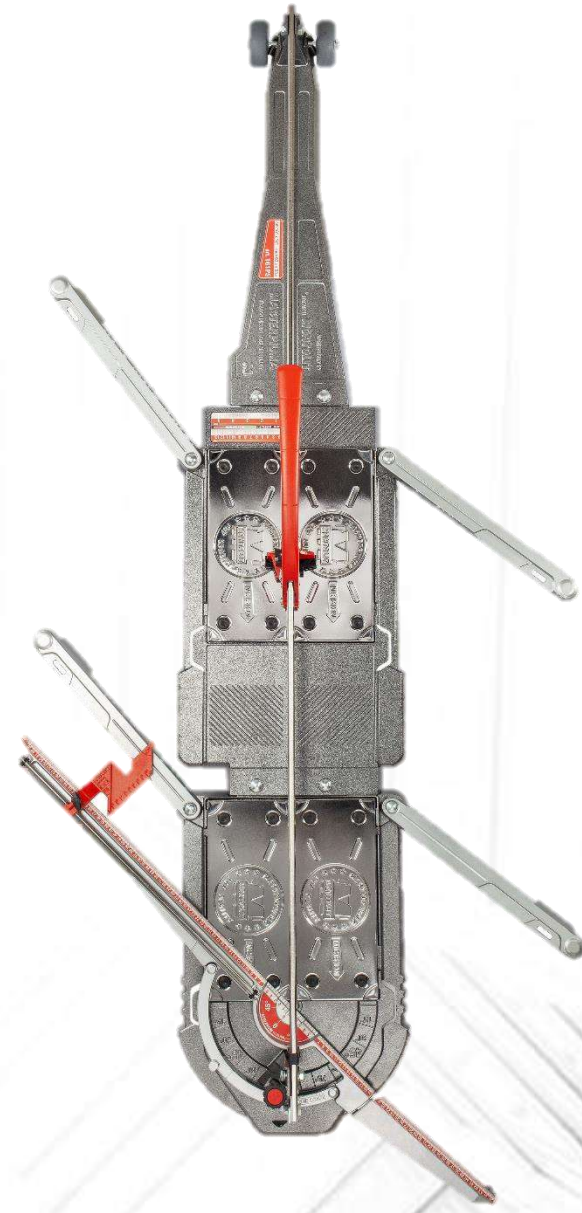

# PRODUCTS RANGE – MASTERPIUMA P5



**MASTERPIUMA**  
PROFESSIONAL TILE CUTTERS



Art. 63P5  
63cm (24,5")



Art. 75P5  
75cm (29")



Art. 93P5  
93cm (36")



Art. 131P5  
131cm (51,5")



Art. 161P5  
161cm (63,5")



- Dimensioni (5 misure)
- Basamento rinforzato
- Estensioni «braccia»
- Squadra goniometrica
- Portarotelle ergonomico

# PRODOTTI – TAGLIPIASTRELLE ELETTRICHE

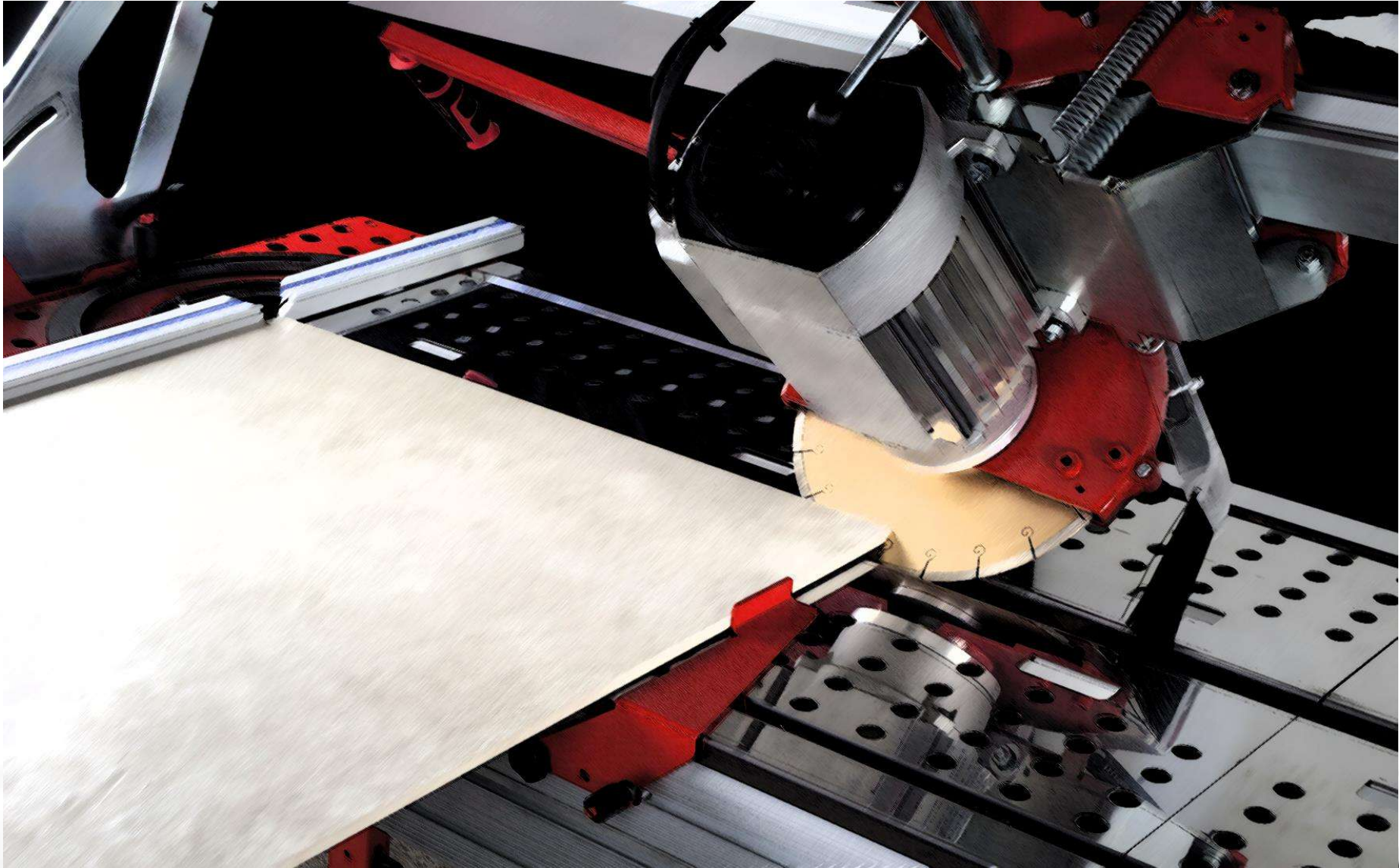

# PRODOTTI – TAGLIAPIASTRELLE ELETTRICHE



101 cm



131 cm



151 cm



181 cm

# PRODOTTI – UTENSILI DIAMANTATI

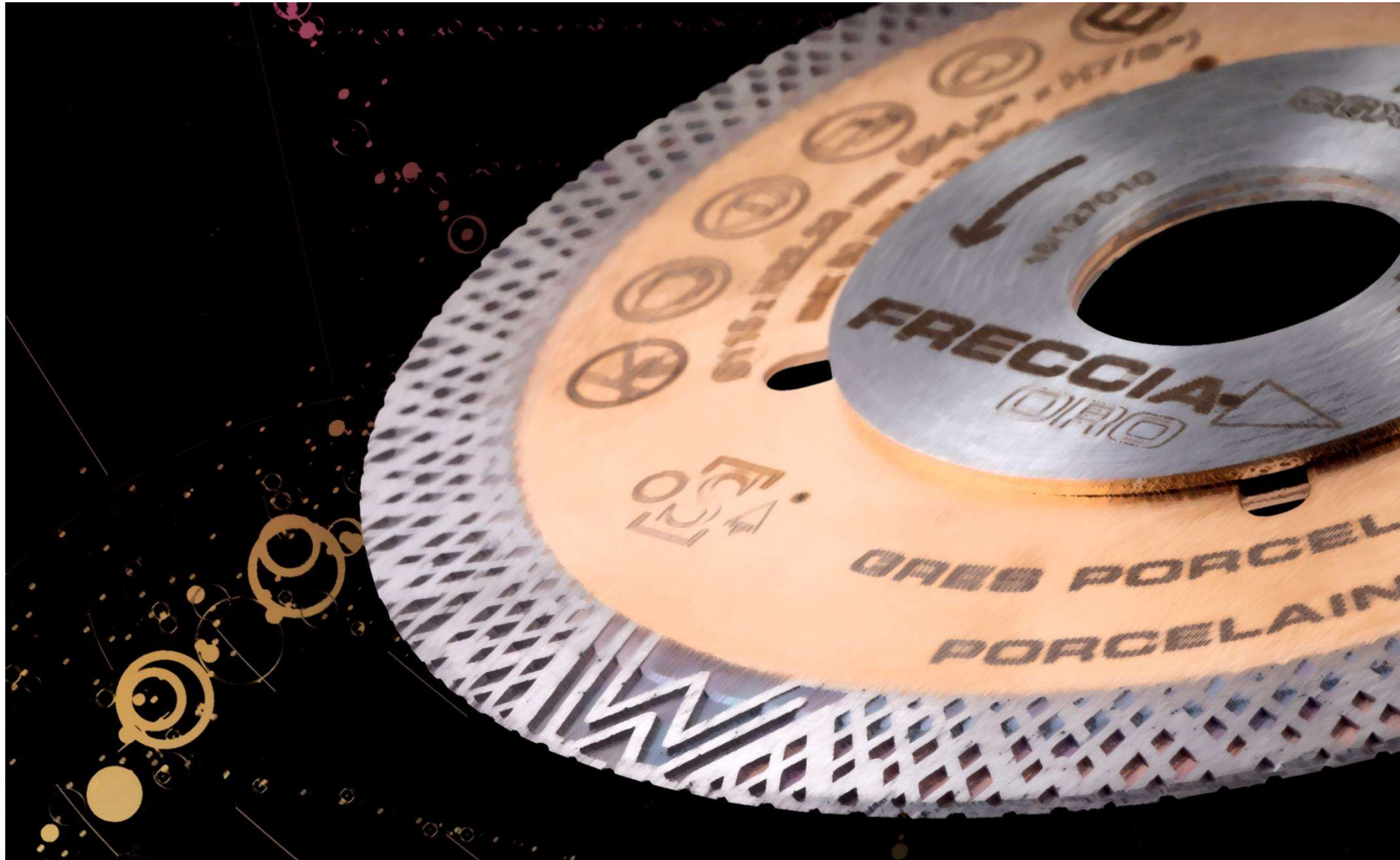



# PRODOTTI – UTENSILI DIAMANTATI

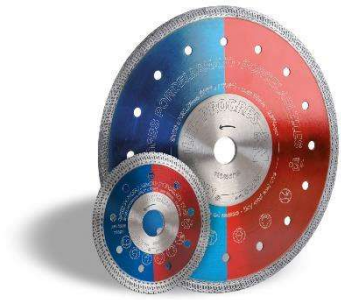

# PRODOTTI PROFESSIONALI PER LASTRE – P300



# PARTNERSHIP TECNICHE



**FLORIM**



**FLORIM**  
stone 161220

# PARTNERSHIP TECNICHE



GRANDE 



**MAXIMUM**®  
FIANDRE EXTRALITE

# TECHNICAL PARTNERSHIP



**COSENTINO®**



# PARTNERSHIP TECNICHE



An advertisement for Kerlite. The left side shows a gallery scene with four tall, narrow, light-colored panels standing in a row. A woman in a black dress and a man in a black shirt are looking at the panels. The right side is a black background with the 'kerlite' logo in white, a circular seal that says 'THE ORIGINAL', and a list of languages: Italiano, English, French, Deutsch, Nederlands, Portugues, Spanish. At the bottom, the COTTO D'ESTE logo and tagline are repeated, along with the text 'Official Website'.

kerlite®

THE ORIGINAL

Italiano English French Deutsch Nederlands  
Portugues Spanish



Official Website

# PRODUCTS RANGE – PRODOTTI PROFESSIONALI PER LASTRE

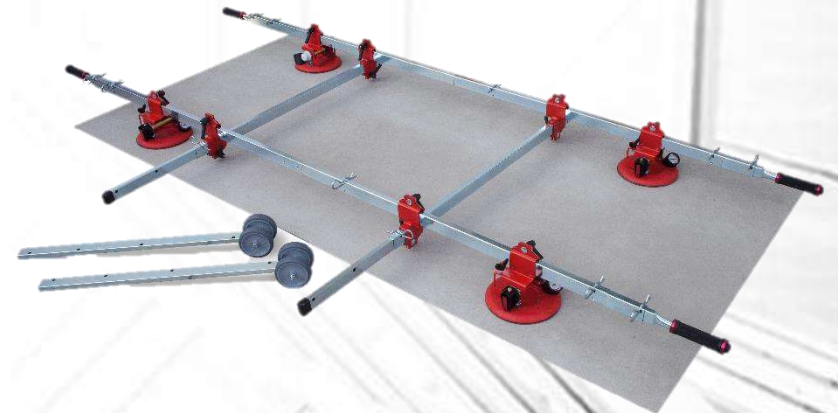



# INNOVATIVE SOLUTIONS – FLASH-LINE 3 / MOTO FLASH 2



# INNOVATIVE SOLUTIONS – BATTLE & BATTLE-PRO-2B



# SOLUZIONI INNOVATIVE

PRODOTTI CON TECNOLOGIA AVANZATA PER RISOLVERE PROBLEMI TECNICI



Problema: Taglio veloce e pulito su vetro e mosaico

Soluzione: Prodotti speciali



**art. 55W2**



**art. 58**

# INNOVATIVE SOLUTIONS

PRODOTTI CON TECNOLOGIA AVAZATA PER RISOLVERE PROBLEMI TECNICI



Problema: evitare rotture e crepe negli angoli e spigoli

Soluzione: tecniche speciali di foratura con  
strumenti professionali



art. FPS



art. FS

# INNOVATIVE SOLUTIONS

PRODOTTI CON TECNOLOGIA AVANZATA PER RISOLVERE PROBLEMI TECNICI

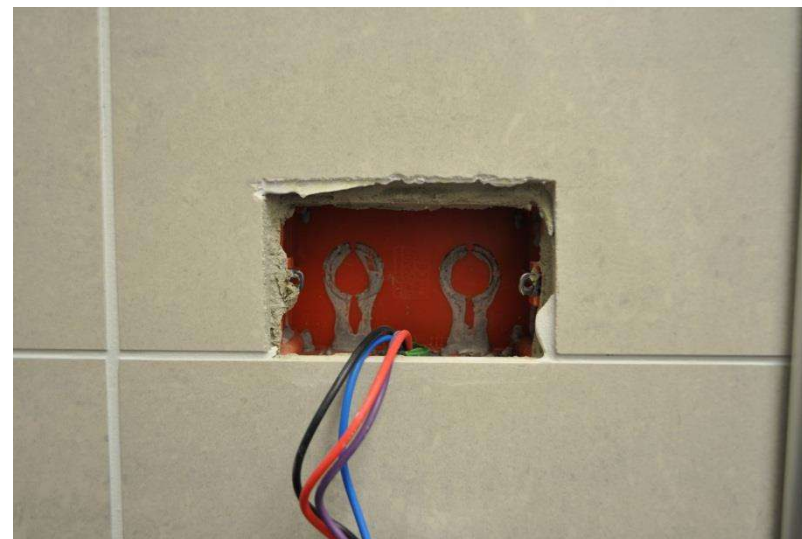
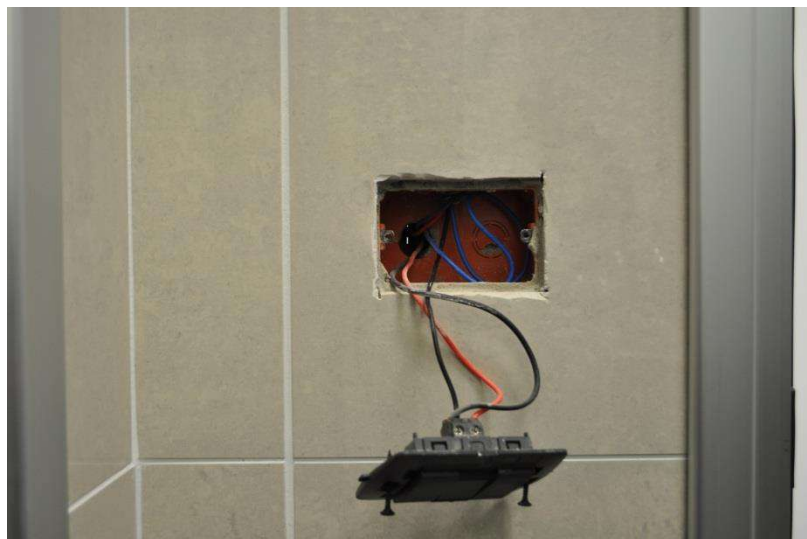

*Problema:*

- 1. tagli squadri per evitare crepe*
- 2. ristrutturazione evitando di rompere altre piastrelle*

*Soluzione:* tecniche speciali di taglio

*disco professionale (85mm – 1 mm spessore)*



**art.TCS85**

# INNOVATIVE SOLUTIONS – DISCHI LAMELLARI DIAMANTATI FLEXIMONT



# INNOVATIVE SOLUTIONS – dischi Tecnologia “DNA”

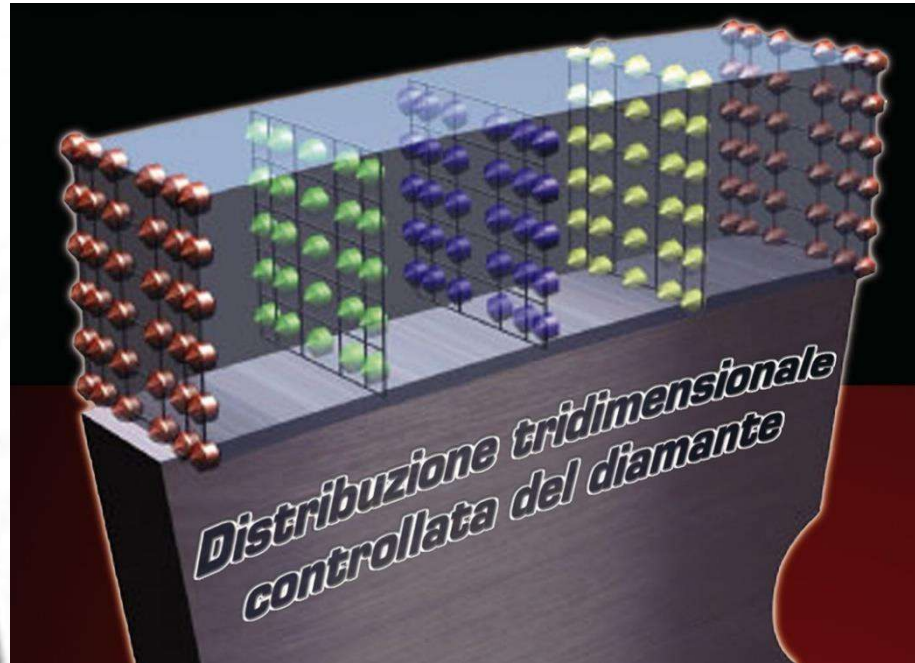
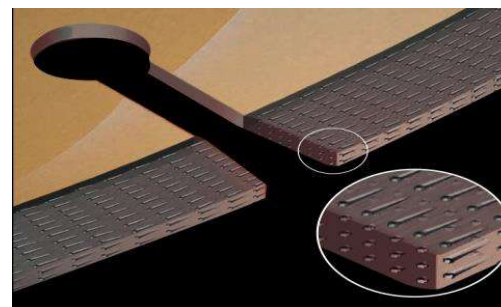
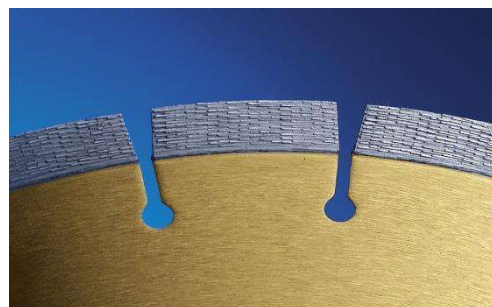
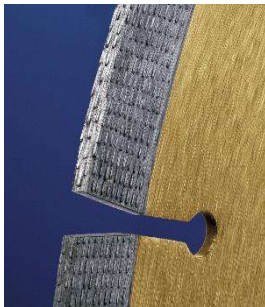
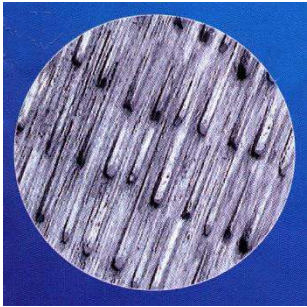



**NUOVI PRODOTTI**



# INNOVATIVE SOLUTIONS – ATLAS

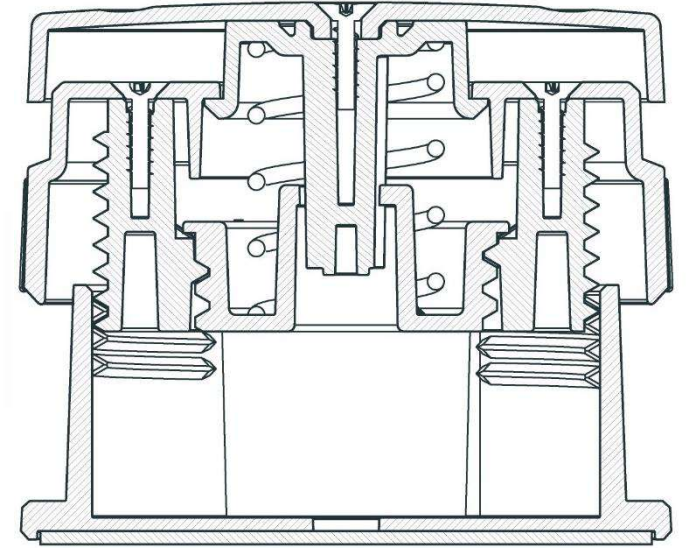
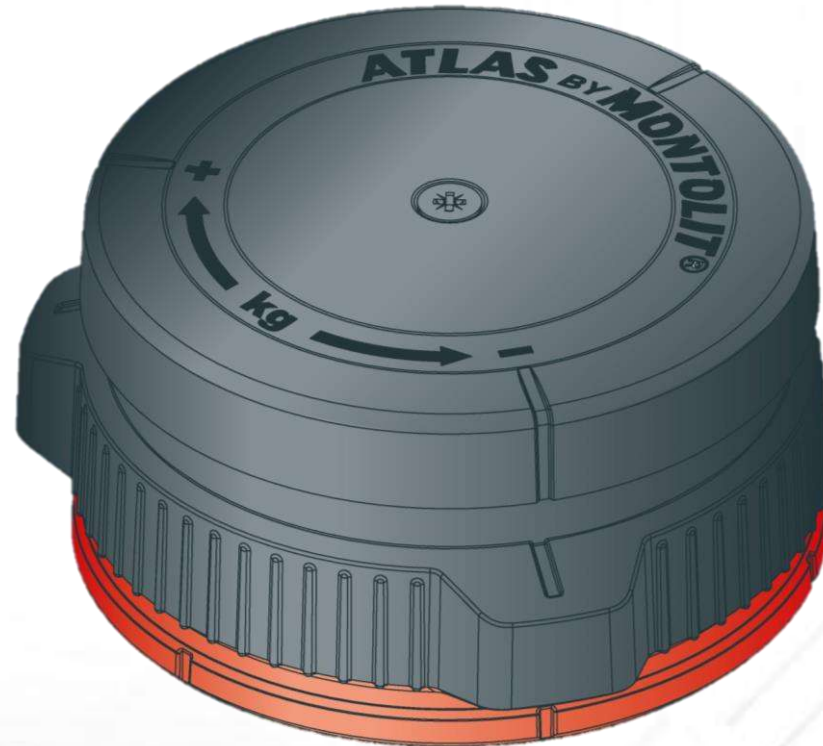
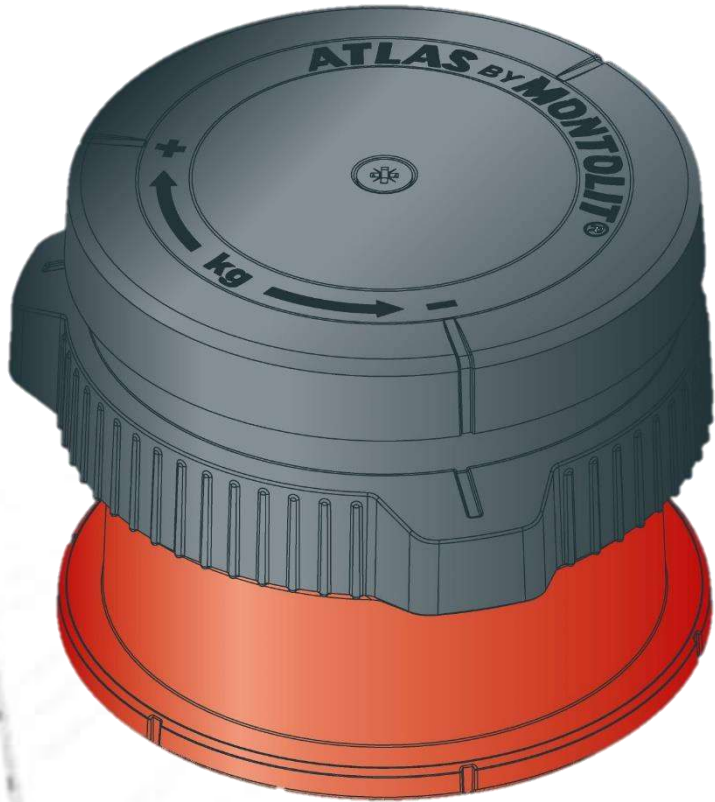

# INNOVATIVE SOLUTIONS – ATLAS



# INNOVATIVE SOLUTIONS – GECONE



# INNOVATIVE SOLUTIONS – GECO E-POWER

SUPERLIFT ART.300-70SL-MOB

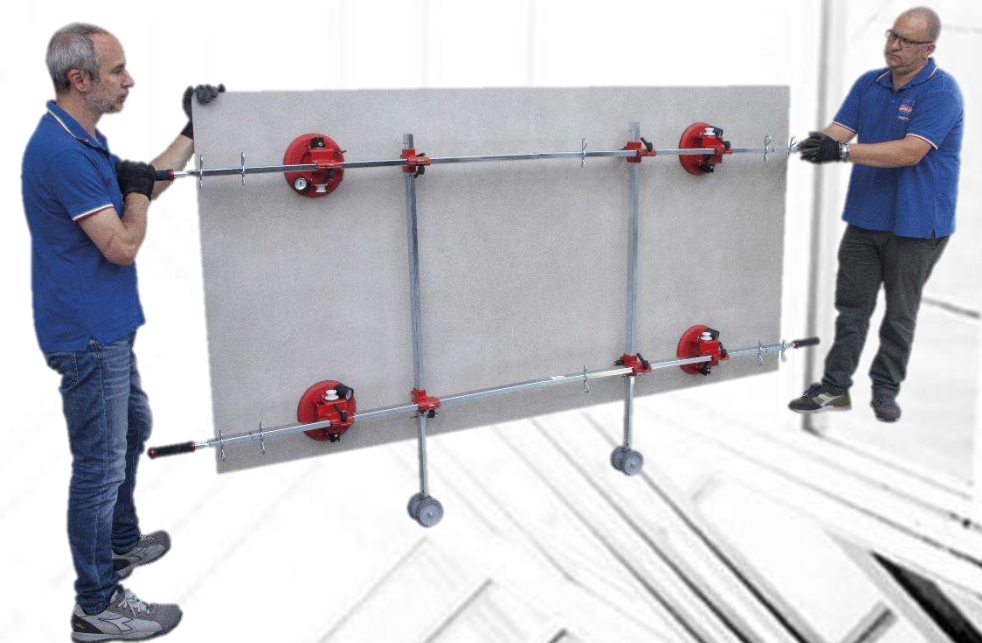
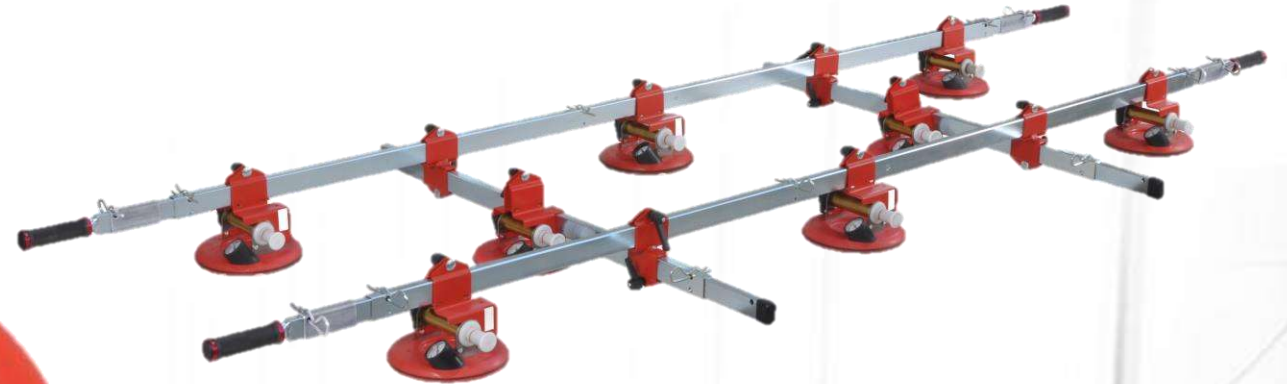

# INNOVATIVE SOLUTIONS – BATTILONE



# INNOVATIVE SOLUTIONS – Mola diamantata per piletta lavabo



**INNOVATIVE SOLUTIONS – DISCHI LAMELLARI DIAMANTATI**

## ***FLEXIMONT-SUPER***

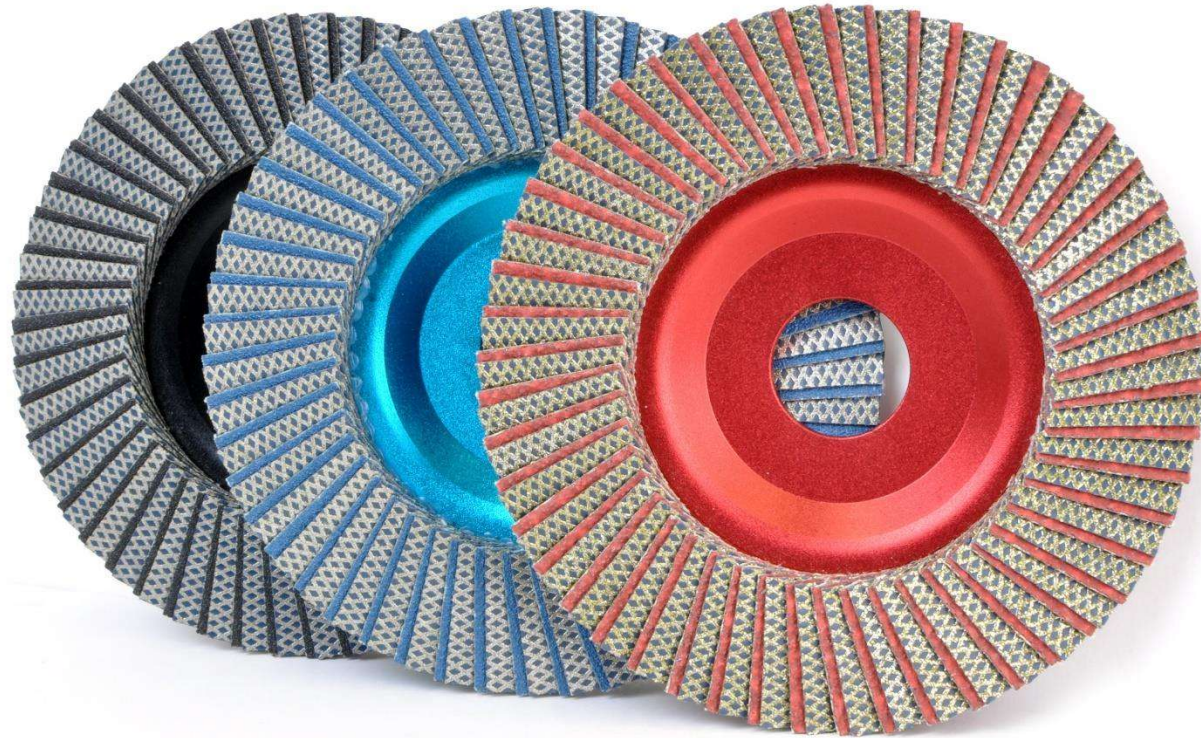
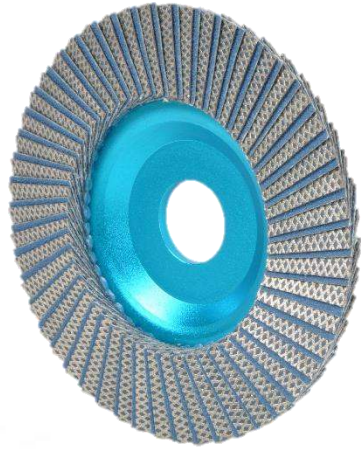

## *5A Generazione*



**Art. FS\_TI ( TITANIO)**

**Diamante Speciale con prestazioni migliori del 30%**





SINCE 1946

75<sup>+</sup>